



# Operation Manual Cabinet Vacuum- Desiccators

Models: F42400-4001,-4101, -4021, -4121, -4011, -4111, -4031, and  
-4131

***Manual No. 942404001 Version 1.0***



## Table of Contents

1	Safety Advice .....	1
1.1	Operation Manual.....	1
1.2	DANGER/CAUTION/NOTICE Alerts .....	1
1.3	Danger Alerts .....	2
1.4	Caution Alerts .....	2
2	Product Description .....	4
2.1	Introduction .....	4
2.2	Characteristics .....	5
2.3	Layout .....	9
3	Unpacking and Installation.....	1 1
3.1	Checking Shipment Damage and Unpacking.....	1 1
3.2	Checking the Contents of the Package.....	1 1
3.3	Installation .....	1 2
3.3.1	Installation Environment.....	1 2
3.3.2	Installation Location .....	1 3
4	Operation.....	1 4
4.1	Operation of the 3-Way Valve.....	1 4
4.2	Vacuum Formation .....	1 6
4.3	Multi-stacking of the Units.....	1 7
4.4	Storage .....	1 8
5	Maintenance.....	1 9
6	Troubleshooting .....	2 0
7	Accessories .....	2 1
8	Appendix.....	2 2
8.1	Technical Specifications.....	2 2
8.2	Disposal of the Unit.....	2 4
8.3	Warranty and Disclaimer .....	2 4
8.4	After-sales Service and Customer Assistance .....	2 4

# 1 Safety Advice



## 1.1 Operation Manual

This manual contains important safety and operation information. You must carefully read, understand, and follow all the instructions in this manual prior to operating this instrument. Keep this manual in a safe place nearby for reference and make it easily available to all users.

## 1.2 DANGER/CAUTION/NOTICE Alerts

This manual highlights DANGER/CAUTION/NOTICE alerts to prevent injury or property damage and also to achieve optimum performance of your instrument.

These alerts are classified into three types in this manual depending on the importance and the risk levels as described below:

Symbols	Meaning
	Ignoring this alert could cause serious or even fatal injury.
	Ignoring this alert could cause serious injury or property damage.
	Ignoring this alert could cause operational problems.

Ensure to read the danger and caution alerts in 1.3 and 1.4 carefully before use.

### 1.3 Danger Alerts

- ◆ **Never install or use this unit in explosive atmospheres.**
- ◆ **Never install this unit near to hazardous or flammable substances.**
- ◆ **Never disassemble, repair, or modify this unit on your own. Doing so will void your warranty and may result in injuries or product damages.**

### 1.4 Caution Alerts

 <b>CAUTION</b>
Ignoring the following cautions could cause serious injury or property damage.

- ◆ **Carefully read all the warning labels before using this unit. And do not remove or damage the warning labels.**
- ◆ **Do not move this unit during operation. When moving it, use the molded-in handles.**
- ◆ **Do not use this unit in wet or moist atmosphere or where water leakage is expected.**



- ◆ Do not use this unit in contaminated atmosphere or where metallic dust exists.
  
- ◆ Do not expose this unit to any heat sources including direct sunlight.
  
- ◆ Do not allow moisture, organic solvent, dust, or corrosive gases to get into this unit.
  
- ◆ Do not use chlorine bleach, ammonia-based cleaners, abrasives, ammonia, or metal scouring pads. Wipe with a soft dampened cloth or a sponge soaked in water or diluted neutral detergent.



## 2 Product Description

### 2.1 Introduction

Congratulations of your purchase of our high-quality cabinet vacuum desiccator which is specially designed to provide maximum benefit for your investment with respect to performance, safety, ease of use, and durability.

This unit is a sturdily constructed 360° transparent vacuum desiccator ideal for storing, drying, cooling, and degassing various materials. The vacuum environment created by this unit provides a very low humidity, contamination-free, corrosion-free, and dust-free environment ideal for:

- storing moisture-sensitive materials such as anhydrides and other hygroscopic compounds as well as materials which are highly reactive with atmosphere
- removing residual solvents or air bubbles
- cultivating anaerobic microbes
- minimizing the reabsorption of humidity and the exposure to air during the drying or the cooling stages of biological/medical/food/materials experiments



- conducting experiments at low pressure
  
- drying at low pressure to minimize the heat effects

Currently eight models of cabinet vacuum desiccators are available from Bel-Art Products with the internal volume ranging from 11 liters to 45 liters. Note that UV blocking models (F42400-4101, -4121, -4111, and -4131) are offered to minimize damages or discoloration of light-sensitive samples by using UV-blocking resin which completely blocks all ranges of UV and the blue spectrum of the visible light.

## **2.2 Characteristics**

### **(1) Outstanding Vacuum Sustainment**

This unit maintains a 1 Torr (133 Pa) vacuum for over 72 hours at room temperature and stays gastight without a vacuum allowing reliable experiments over extended periods.

### **(2) Integral Molding of the Polycarbonate Body**

Unlike conventional vacuum desiccators, the uni-body construction is molded as



a single piece (except the door) for maximum vacuum retention.

Shock-resistant, high-tensile strength, and transparent polycarbonate body provides extreme durability as well as 360° visual observation from outside.

### **(3) Viton® 3-Way Valve**

This unit comes standard with a Viton® 3-way valve offering consistent and uniform vacuum draw, vacuum release, or gas exchange without the inconvenience of connecting and disconnecting pump hoses to the unit.

If needed, up to 4 valves can be installed using the built-in ports at the base of the unit and the positioning of the valve(s) can be also easily changed.

### **(4) Airtight Door Sealing**

The door is located in the front for convenient access. Equipped with a special door latch which is easily closed at normal pressure and a greaseless vacuum seal using high-quality silicon gasket, this unit enables airtight sealing between the door and the body and quick vacuum formation.

### **(5) Multi-stackable Design**





The cabinet models come in a variety of capacities to suit the user's needs with the internal volume ranging from 11 liters to 45 liters.

With the same foot print, different models can be stacked together in any convenient fashion allowing for lab space saving.

#### **(6) Efficient Use of the Internal Space**

Compared to round desiccators, cabinet desiccators provide larger usable volumes with the same footprint. In addition, the internal space can be more efficiently utilized by using the standard perforated shelves designed for efficient airflow.

Two or three perforated shelves are provided and, if needed, up to four or six shelves can be used for efficient storage of the samples. (Refer to Product Checklist or Specifications for details.)

#### **(7) Easy Vacuum Level Checking**

With a built-in vacuum gauge installed on the front door, checking the vacuum level is quick and easy.

#### **(8) Desiccant Tray**



This unit comes standard with a desiccant tray. Desiccants are sold separately.

## 2.3 Layout

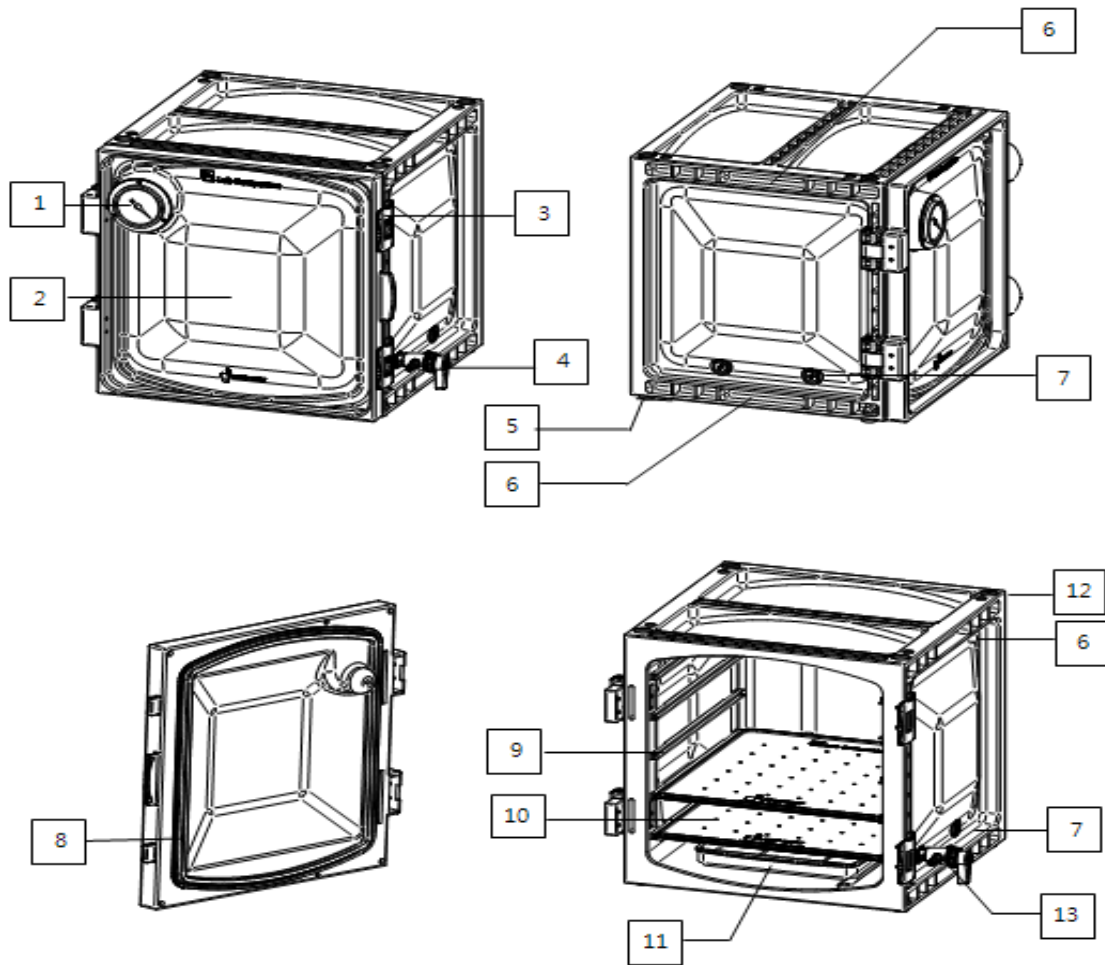

- (1) **Vacuum Gauge**
- (2) **Door**
- (3) **Door Latch**
- (4) **3-Way Valve**
- (5) **Non Slip Feet**
- (6) **Groove Handle**
- (7) **Valve Port Plug**
- (8) **Door Seal**
- (9) **Shelf Rail**



- (10) **Perforated Shelves**
- (11) **Desiccant Tray**
- (12) **Stacking Groove**
- (13) **Air Inlet/Outlet Nozzle**



### 3 Unpacking and Installation



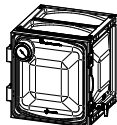
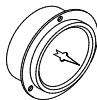

#### 3.1 Checking Shipment Damage and Unpacking

Upon receiving the instrument, check to ensure that no damage has occurred during shipment. It is important that any damage that occurred during shipment is detected before unpacking. If you find such damage, the carrier must be notified immediately.

#### 3.2 Checking the Contents of the Package

After unpacking, check to ensure that all the parts and accessories described below are included in the package. If not, contact your dealer immediately.

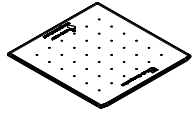
Item		Figure	Quantity
Main Body			1
Vacuum Gauge			1
3-Way Valve			1
Port Plug	F42400-4001, -4101		1
	F42400-4021, -4121, -4011, -4111, -4031, and -4131		3
Door Seal			1

			
<b>Desiccant Tray</b>			1
<b>Perforated Shelves</b>	<b>F42400-4001, -4101, -4021, and -4121</b>		2
	<b>F42400-4011, -4111, -4031, and -4131</b>		3
<b>User Manual</b>			1

### 3.3 Installation

#### 3.3.1 Installation Environment

<b>NOTICE</b>
Avoid exposure to any heat sources including direct sunlight.

This unit is designed for indoor use in laboratory environments. The conditions for proper installation are as follows:

Permissible Ambient Temperature	5 to 40°C (41 to 104°F)
Permissible Relative Humidity	Below 80%
Permissible Altitude	0 to 2,000 m (6,562 ft)

### 3.3.2 Installation Location

<b>NOTICE</b>
<ul style="list-style-type: none"><li>● Install the unit on a level surface</li><li>● Install the unit at least 30cm away from other equipment</li></ul>

- Install the unit on a level surface
- Install the unit at least 30cm away from other equipment

## 4 Operation

### ⚠ CAUTION

- Do not form a vacuum when airtight containers are inside the unit
- Note that this unit cannot be autoclaved
- When attaching other equipments or additional 3-Way valves after removing the port plugs, use proper O-rings and nuts for tight sealing
- When putting high-temperature samples inside the unit, cool them thoroughly in advance or make sure that they are not in direct contact with the interior of the unit to avoid interior damage

### 4.1 Operation of the 3-Way Valve

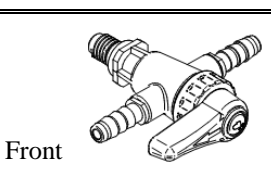
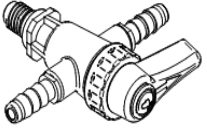
ITEM	Front Nozzle	Rear Nozzle
	Open	Closed
	Closed	Open

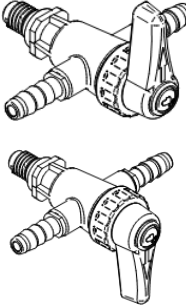

	Closed	Closed
---	--------	--------

## 4.2 Vacuum Formation

The procedures for vacuum formation are as follows:

- (1) When using the unit for drying purposes, fill the tray with desiccants and put it inside prior to operation
- (2) After putting the samples inside the unit, firmly close the door by locking the two latches properly. You will hear a click sound when the latch is properly engaged
- (3) Connect the vacuum pump hose to one of the two nozzles of the 3-Way valve
- (4) After activating the vacuum pump, turn the valve handle towards the nozzle to open it and read the vacuum gauge to check whether the vacuum is forming properly
- (5) When the desired vacuum level is achieved, turn the valve handle until it is perpendicular to the nozzle to close it and check the vacuum gauge whether there is any leakage
- (6) When releasing the vacuum, slowly turn the valve handle towards the opposite nozzle to return to the normal pressure

### CAUTION

- Do not impact or drop the unit when a vacuum is formed inside
- When forming or releasing a vacuum, turn the valve handle slowly to avoid rapid pressure change. If not, the stored samples can be damaged or dispersed

- When forming a vacuum, install a cold trap in front of the vacuum pump.  
Moisture and chemicals from the samples may result in damages to the pump
- Do not let the body of the unit into direct contact with acetone, benzene, toluene, chloroform, cresol, sodium hydroxide, highly concentrated nitric or sulfuric acid, acetic acids, or strong chlorine-based solvents
- Ensure that the door seal is not damaged by strong acid or base. Damaged seal can cause malfunction of the unit
- When a vacuum is formed inside the unit, do not apply excessive force to the 3-way valves, the vacuum gauge, or any of their vicinities. Any damages caused by external forces can cause malfunction of the unit
- When the unit is not forming a vacuum, keep the valve handle perpendicular to the nozzles
- When relocating the unit, use the built-in groove handles instead of holding on to other protruded parts such as the vacuum gauge or 3-Way valves

### **4.3 Multi-stacking of the Units**

These cubic vacuum desiccators are designed to be easily multi-stacked together by locking the feet of the unit into the stacking grooves located on the top surface of another unit as shown below:

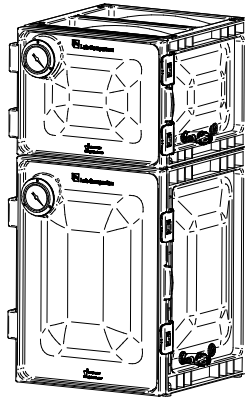

#### 4.4 Storage

If this unit is not used for an extended period of time, clean the instrument with soft cloth and store it in dry place after packing it properly.

## 5 Maintenance

### CAUTION

- If the unit is contaminated, wear chemicals-resistant gloves before cleaning
- Regularly check the 3-way valves, the vacuum gauge, or any of their vicinities for any damage
- Regularly check the vacuum seal as well as the surface where the body and the base are in contact and keep them always clean and undamaged
- Make sure to clean the silicone gasket regularly using diluted neutral detergent. For thorough cleaning, detach the seal from the lid
- Do not use chlorine bleach, ammonia-based cleaners, abrasives, organic solvents, or metal scouring pads when cleaning. Use a soft cloth all the time.

## 6 Troubleshooting

Problem	Cause	Corrective Action
<b>Vacuum Malfunction</b>	Contaminated surface between the door and the body	Thoroughly clean the surface with a soft cloth using diluted neutral detergent
	Damaged door gasket	Replace the gasket
	Unsuitable room temperature	Check the temperature whether it is within the operating range
	Misplaced or damaged 3-way valve	Check whether the valve is properly set. If damaged, replace it with a new one
	Damaged vacuum gauge	Replace the gauge



## 7 Accessories

See enclosed addendum for Accessories Parts List

## 8 Appendix

### 8.1 Technical Specifications

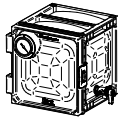
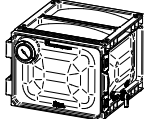
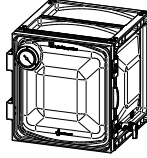
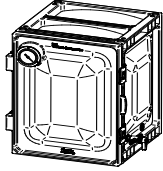
Models F42400-		4001, 4101	4021, 4121	4011, 4111	4031, 4131
Figure					
Internal Volume (L)		11	23	35	45
Vacuum	Gauge Range (MPa)	0 ~ -0.1(Analog)			
	Max. Permissible	1.33 x 10 <sup>-4</sup> (1Torr)			
	Nozzle Diameter (mm)	Ø 9.5			
Material	Body, Shelves	PC( Polycarbonate)			
	3-Way Valve, Latch, Desiccant tray	PP (Polypropylene)			
	Vacuum Gasket	Silicone			
Dimensions (mm)	Overall (W x D x H)	322x285x271	420x397x281	420x397x381	420x397x491
	Door Opening (W x H)	208x238	295x245	295x345	295x445
	Shelf (W x D x H)	202x204x6.5		289x304x11	
	Desiccant Tray (W x D x H)	158x194x24		218x268x268	
	Net Weight (kg)	4.2	8.2	10.8	12.2
Shelves	Number of Shelves (standard/maximu)	2/4	2/4	3/5	3/6





	<b>m)</b>				
	<b>Max. Load/Shelf (kg)</b>	3	5	5	5
<b>Color*</b>		Amber			
<b>UV Protection (Range)*</b>		UV A,B,C 100% (200~450nm)			

\* Note: Applies only to Models F42400-4101, -4121, -4111, and -4313.



## **8.2 Disposal of the Unit**

Disposing of the unit must be done in an environmentally responsible way if it has been potentially exposed to bio-agents or radioactive samples. Failure to follow stringent requirements for appropriate disposal may lead to actions against you and your organization.

- (1) First, check with your laboratory or organization to ensure that you are following all the policies and procedures for disposal of laboratory equipments and wastes.
  
- (2) If not possible, contact your local governing body for regulations regarding disposal of laboratory equipments. Jeio Tech highly recommends you to find a local service provider that can properly dispose of your unit.

## **8.3 Warranty and Disclaimer**

See enclosed Warranty Card for conditions and requirements.

## **8.4 After-sales Service and Customer Assistance**

Our after-sales service responds to your questions concerning maintenance and repair of your unit as well as spare parts. In case of a warranty claim, repair or purchase of replacement parts or in case of queries or other problems, please contact your local dealer or Bel-Art Products representative.



- ✧ The contents of this manual can be changed or upgraded without prior notice.
- ✧ The copyright of this manual is reserved by Bel-Art Products.



## Addendum to User Manual

### Accessories Parts List for Cabinet Model Desiccators

Bel-Art Accessory No.	Unit of Measure	Accessory Description	Used with Bel-Art Desiccator Number(s)
942404011	EA	Vacuum Gauge	F42400-4001, -4101, -4021, -4121, -4011, -4111, -4031, -4131
942404010	EA	Door Seal	F42400-4001, -4101
942404009	EA	Door Seal	F42400-4021, -4121
942404008	EA	Door Seal	F42400-4011, -4111
942404007	EA	Door Seal	F42400-4031, -4131
942404006	EA	Desiccant Tray	F42400-4001, -4101
942404005	EA	Desiccant Tray	F42400-4021, -4121, -4011, -4111, -4031, -4131
942404004	EA	Perforated Shelves	F42400-4001, -4101
942404003	EA	Perforated Shelves	F42400-4021, -4121, -4011, -4111, -4031, -4131
942404002	EA	3-Way Valve (For Cabinets)	F42400-4001, -4101, -4021, -4121, -4011, -4111, -4031, -4131
942404001	EA	User Manual - Cabinet Models	F42400-4001, -4101, -4021, -4121, -4011, -4111, -4031, -4131

661 Route 23 South, Wayne, NJ 07470

TEL: 1-800-4BEL-ART • FAX: 973-694-7199 • [www.belart.com](http://www.belart.com)

Scienceware® is a registered TM of Bel-Art Products.  
 Bel-Art Products assumes no obligation or liability for any advice furnished by it, or for results obtained with respect to these products.  
 All such advice is given and accepted at the buyer's risk.  
 © 2012 Bel-Art Products. All Rights Reserved.

